



meeknet.co.uk

The BMW 8 Series Coupé.
An outstanding sports Coupé in luxury style –
high-technology and superlative design all in one.



8

Views

Pages 4-15

Drive technology

Pages 16-17

Safety

Pages 18-19

Interior

Pages 20-23

840Ci Sport

Page 24

**BMW Service,
BMW Finance**

Page 25

Tables

Specifications

Pages 26-27

**Standard and optional
equipment**

Pages 28-29

Personal Line

Pages 30-31

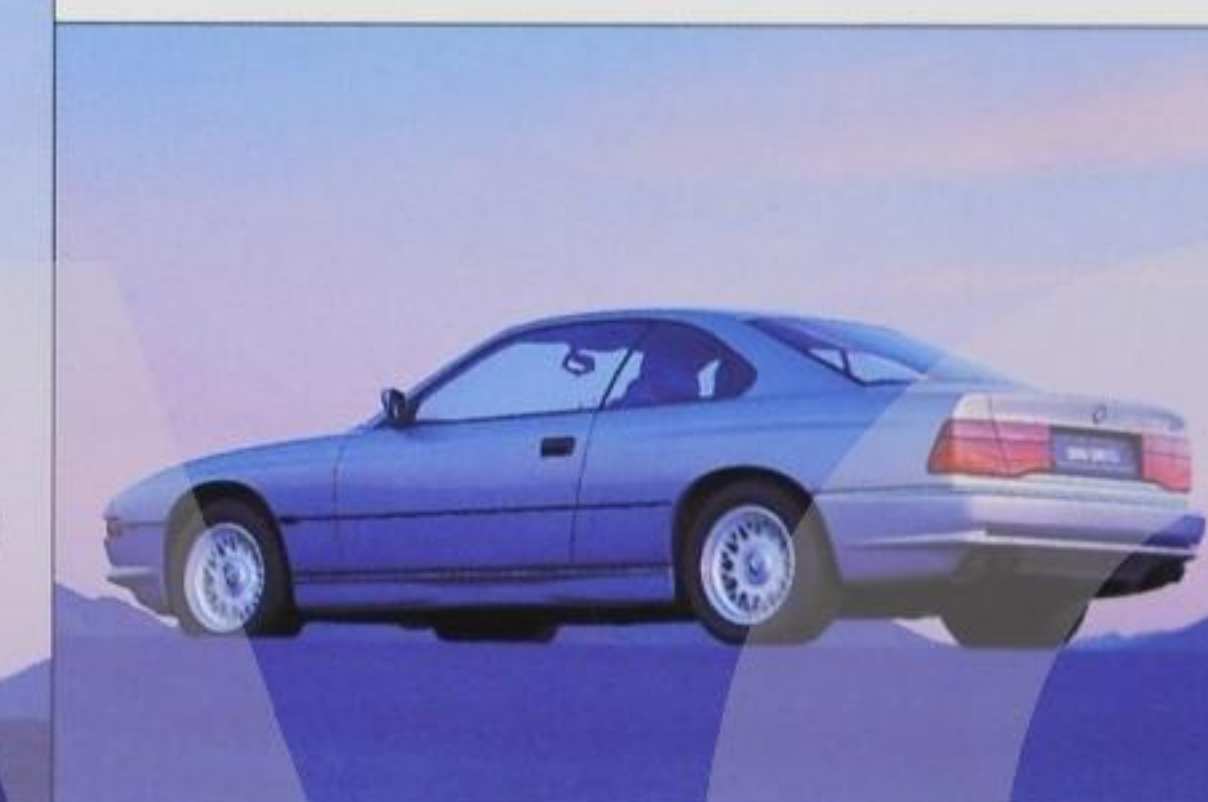

The passion for motoring reaches new heights in the BMW 8 Series: a car offering the virtually perfect blend of mobility, luxury, and active driving pleasure. The enhanced sports version, the 840Ci Sport has been specifically designed to make motoring a rewarding experience time and again, regardless of whether you prefer a more dynamic or relaxed style at the wheel. The BMW 8 Series is also thrilling in its styling and paves the way as a spearhead in technology. This is borne out particularly by the 8 Series' extremely sophisticated suspension and high performance engine: the 4.4-litre 8-cylinder.

Outstanding beauty from every angle will be your first impression of the BMW 840Ci Sport. This car offers a perfect coupling of sheer driving pleasure and supreme aesthetic beauty. With the enhancement of the M sports suspension the 840Ci Sport represents automotive progress in its purest form.



The unique style and class
of the BMW 840Ci Sport is

the result of passion for
aesthetic design blended

perfectly with progressive
automotive technology.



BMW 840Ci





Sleek and elegant, muscular yet graceful, the BMW 840Ci allows your imagination to indulge in a much broader definition of top performance than that of power alone.

Featuring a 4.4-litre 8-cylinder engine, the BMW 840Ci offers performance far beyond the usual.

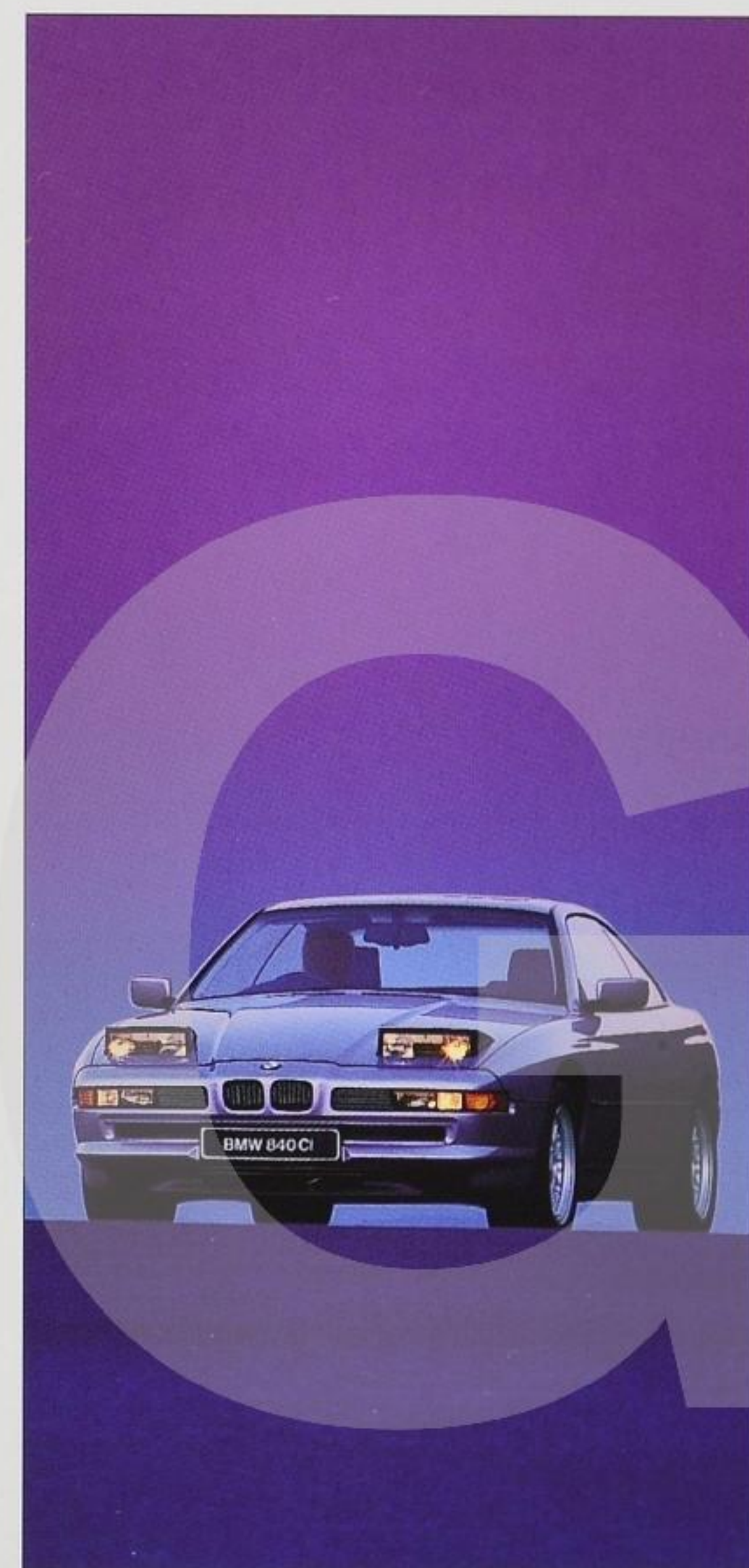

Not least, it is the striking, powerful face of the car that makes the BMW 8 Series so unique.





Whatever perspective you choose, you will be thrilled by the clear, consistent design of the BMW 8 Series.

A comfort-oriented luxury Coupé or a high performance sports car? The BMW 8 Series goes far beyond conventional standards, offering a unique driving experience in the guise of the 8-cylinder 840Ci Sport.

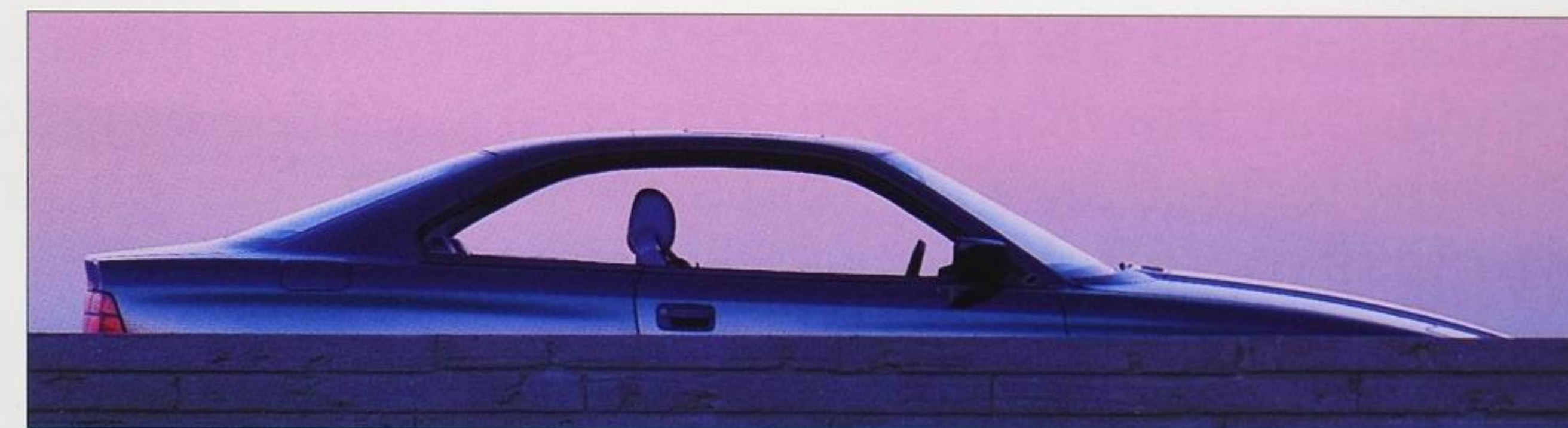

The impressive lines of the Coupé accentuate the dynamic character of the BMW 8 Series.

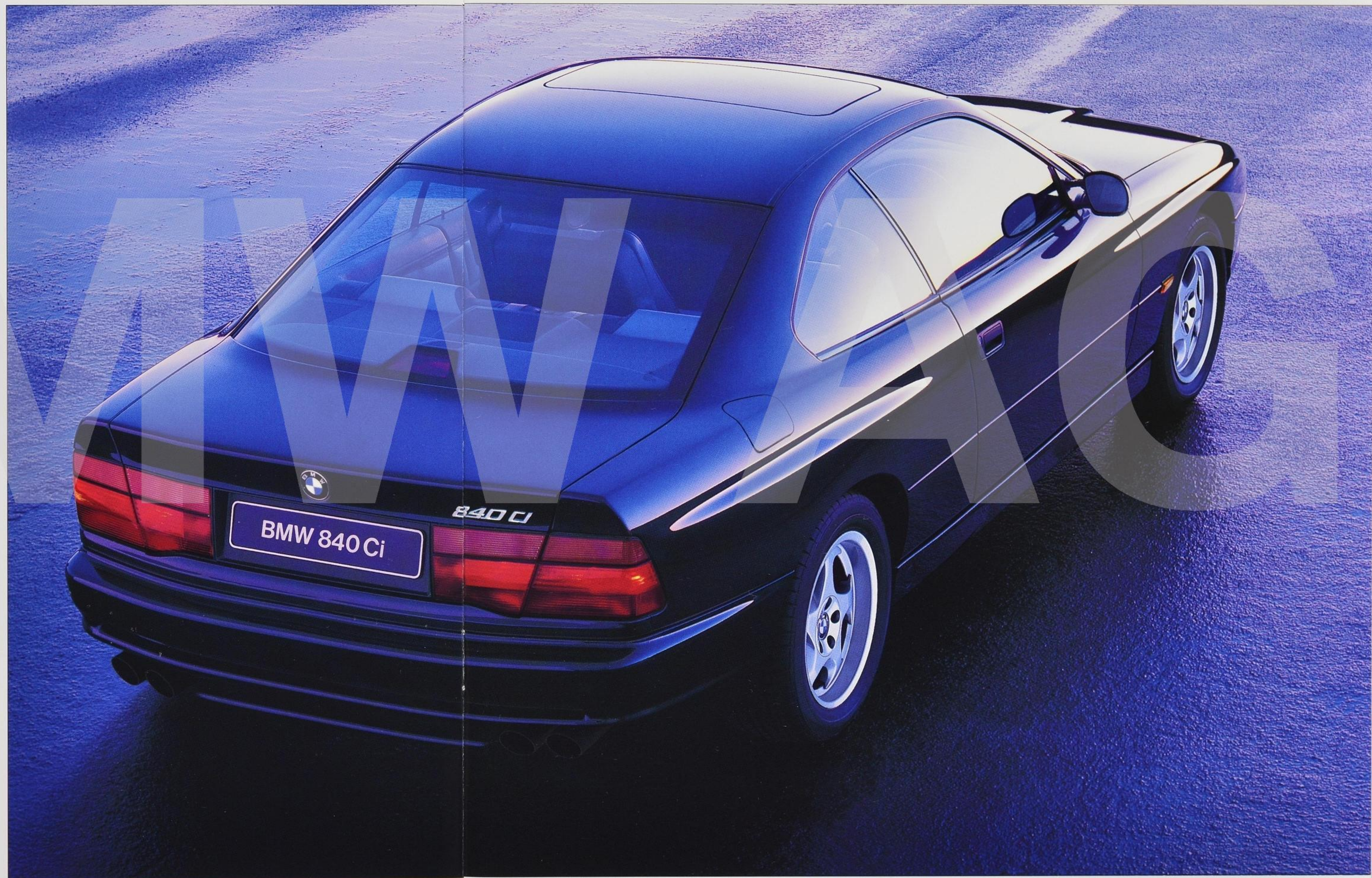

The exclusive class of the BMW 8 Series Coupé results, inter alia, in a unique standard of function benefiting from superior ergonomics. And it is characterised by the most supreme design featuring exquisite, first-class materials.

Ensuring efficient and relaxed interaction of man and machine, the driver-oriented cockpit in the 840Ci Sport offers ideal conditions for exclusive

motoring pleasure. The result is a combination of style and function that's simply sensational.



Innovative engine technology makes the seemingly impossible possible: to develop more power on a lot less fuel. Our latest example of this outstanding ability is the new, state-of-the-art 8-cylinder displacing 4.4 litres.

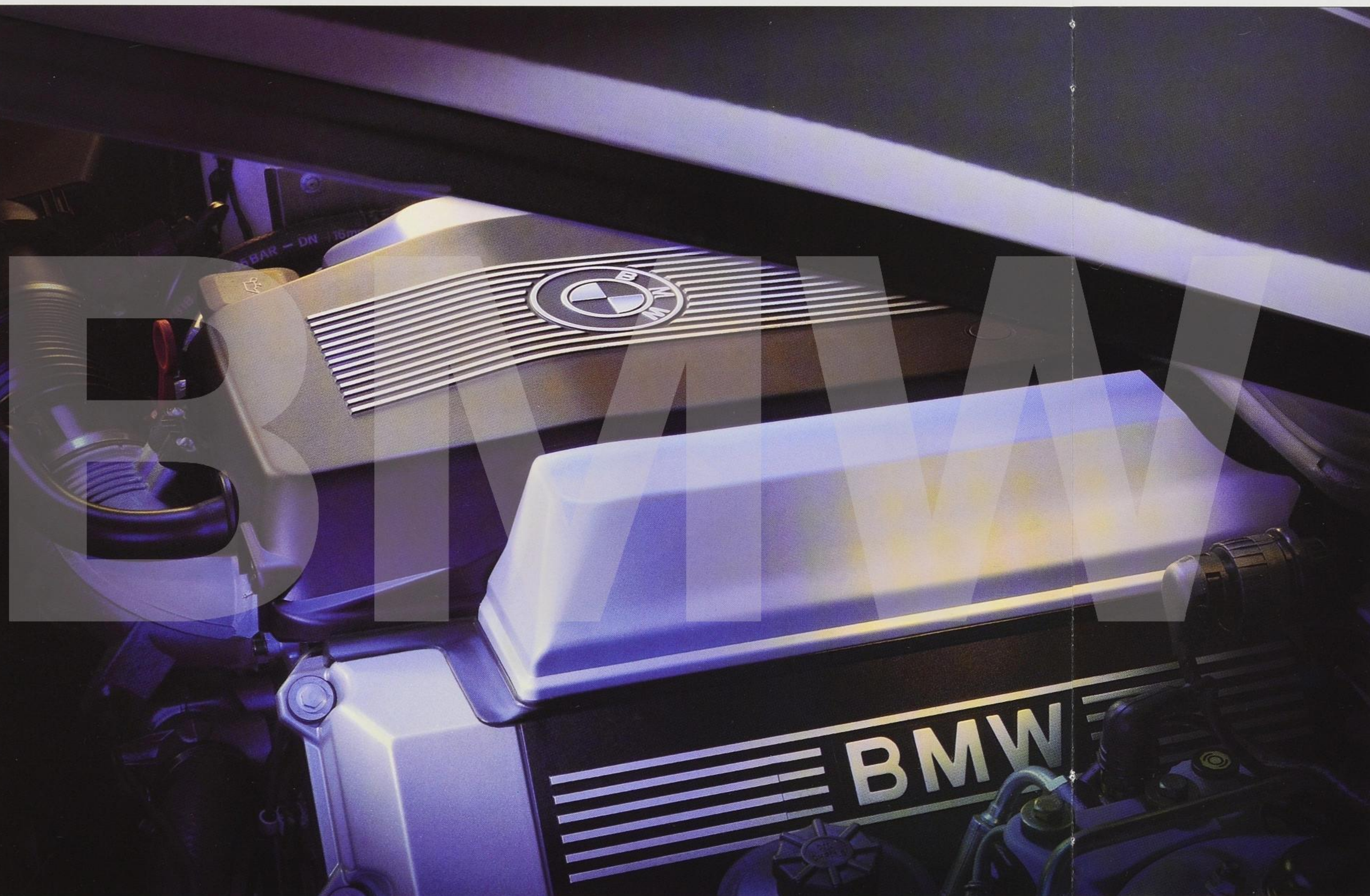

The 8-cylinder power unit displacing 4.4 litres in the BMW 840Ci and 840Ci Sport ensures even more drive comfort, improved engine noise management, and enhanced fuel economy, at the same time offering the

very best in flexibility, performance and low cost of ownership. This is attributable not only to the increase in engine size, but also to the fine tuning of the camshafts and valve drive, the engine cooling system geared to

specific motoring requirements, and the new electronic engine management.



Steptronic transmission combines the comfort and safety of the Adaptive Gearbox System (AGS) with the freedom of choice of a manual gearbox. When

overtaking, for example, you enjoy optimum flexibility while on winding roads you can adjust gearshift behaviour to your personal style of motoring.

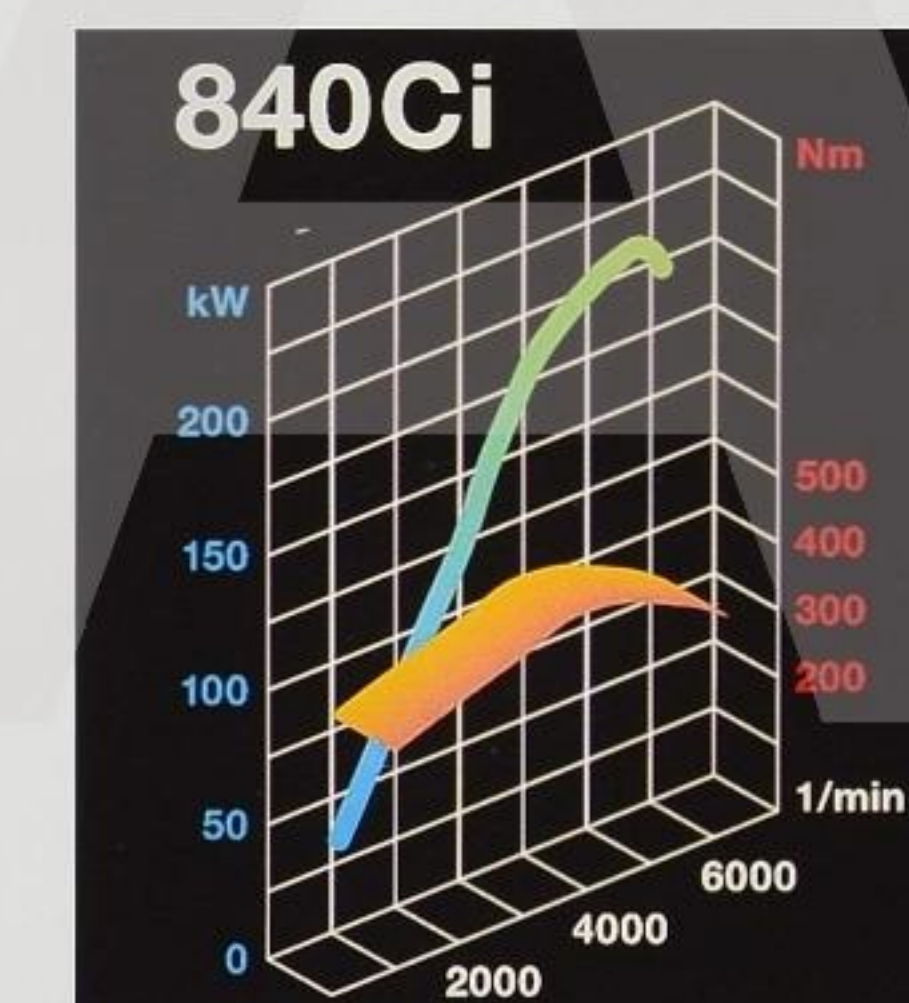

Superior torque throughout the entire speed range gives the 840Ci and 840Ci Sport outstanding agility and performance on the road.

Digital Motor Electronics (DME) featured by BMW is the epitome of innovative, future-oriented engine management. Achieving the highest standard of precision, it controls, monitors and masterminds all engine functions such as the ignition, fuel injection, oxygen sensor control, and many other additional items. Accordingly, DME ensures superior fuel efficiency and very good emission control under all running conditions.

Cylinder-specific knock control acts against any factors which might have a negative influence on the combustion process. Low-grade fuel or very high ambient temperatures, for example, make the pressure and temperature in the combustion chamber increase considerably, the engine therefore starting to knock. This is registered by knock sensors, the signal generated in this way being transferred directly to the Digital Motor Electronics (DME), which, within fractions of a second, will redefine the ignition angle and timing for each cylinder. The result is a smooth combustion process in all cylinders and at all times, the engine being able to run efficiently and without problems on virtually all grades of fuel.

The benefit of the automatic transmission with **Adaptive Gearbox System (AGS)** in the 840Ci and 840Ci Sport is that it determines the optimum gear in each situation. And it gives you the choice of four driving programs ranging from a particularly economical program all the way to a very sporting program. To recognise the driver's style of motoring, AGS constantly monitors the position and operation of the accelerator. Then it compares wheel slip and drive forces, adjusting gearshifts to road conditions categorised as "normal", "winter", and "mountains/starting off". Finally, to add the ultimate touch, AGS takes each specific driving situation into account and avoids unnecessary gearshifts – for example in stop-and-go traffic or in bends. The result is not

only extra comfort, but also extra safety on the road.

Steptronic transmission in the 840Ci and 840Ci Sport allows you to choose either the benefits offered by AGS or a manual gearshift. To choose gears individually, all you do is move the selector lever from position "D" straight into the manual shift gate. To shift up one gear at a time, just move the selector lever forward briefly, to shift down, move it to the rear. In each case the gear in mesh is shown in the instrument cluster. And when you wish to switch back to automatic transmission, simply move the selector lever to the right into position "D".

The **camshafts with eccentrically displaced intermediate segments** largely compensate for any imbalance caused by the valve drive system. Since this dispenses with the need for additional compensation shafts, the result is excellent smoothness with minimum weight.

Contrary to conventional power steering, **Servotronic** offers power assistance as a function of your actual road speed, and not as a function of engine speed. The advantage is particularly efficient power assistance for example when parking, with the servo effect decreasing at higher road speeds.

In the event of an accident, the **crash sensor** switches on the interior lights and hazard warning flashers. It also deactivates the central locking, allowing helpers to get into the car more quickly in the event of an emergency.

Ellipsoid headlights for the low beam and foglamps work in principle in the same way as a slide projector. The only difference is that the slide is replaced by a diaphragm giving the light beam exactly the contours required for optimum illumination of the road ahead, light therefore being literally projected on to the road. The advantages of this system are even better illumination of the road ahead, better illumination

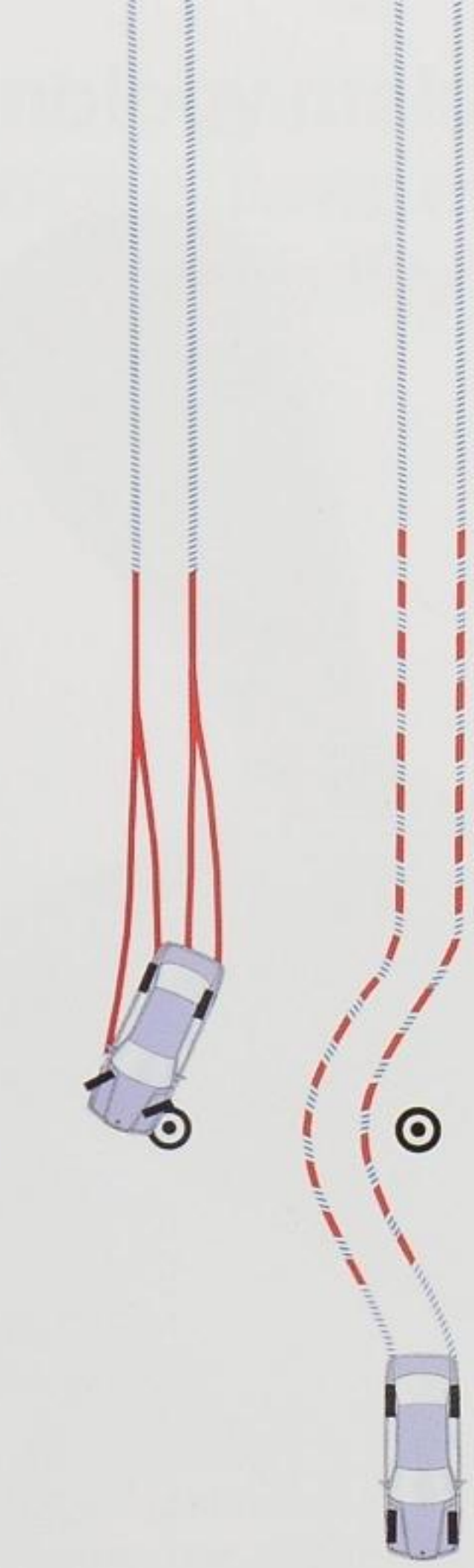

The highly sophisticated **ABS anti-lock brake system** provides outstanding reserves in critical situations, thus keeping you in full control of your car even when applying the brakes in a panic situation.

Driving safety and motoring comfort of the highest calibre. Thrilling supremacy wherever you go is provided by the unique suspension combining a double-joint spring strut front axle with **BMW's multi-arm integral rear axle**. Driving characteristics are therefore excellent in all situations, roll comfort and noise control are enhanced to the highest standard.



The suspension is further supported by **Automatic Stability Control + Traction (ASC+T)** for even greater safety, for example on slippery roads or in tight bends on twisty mountain roads.

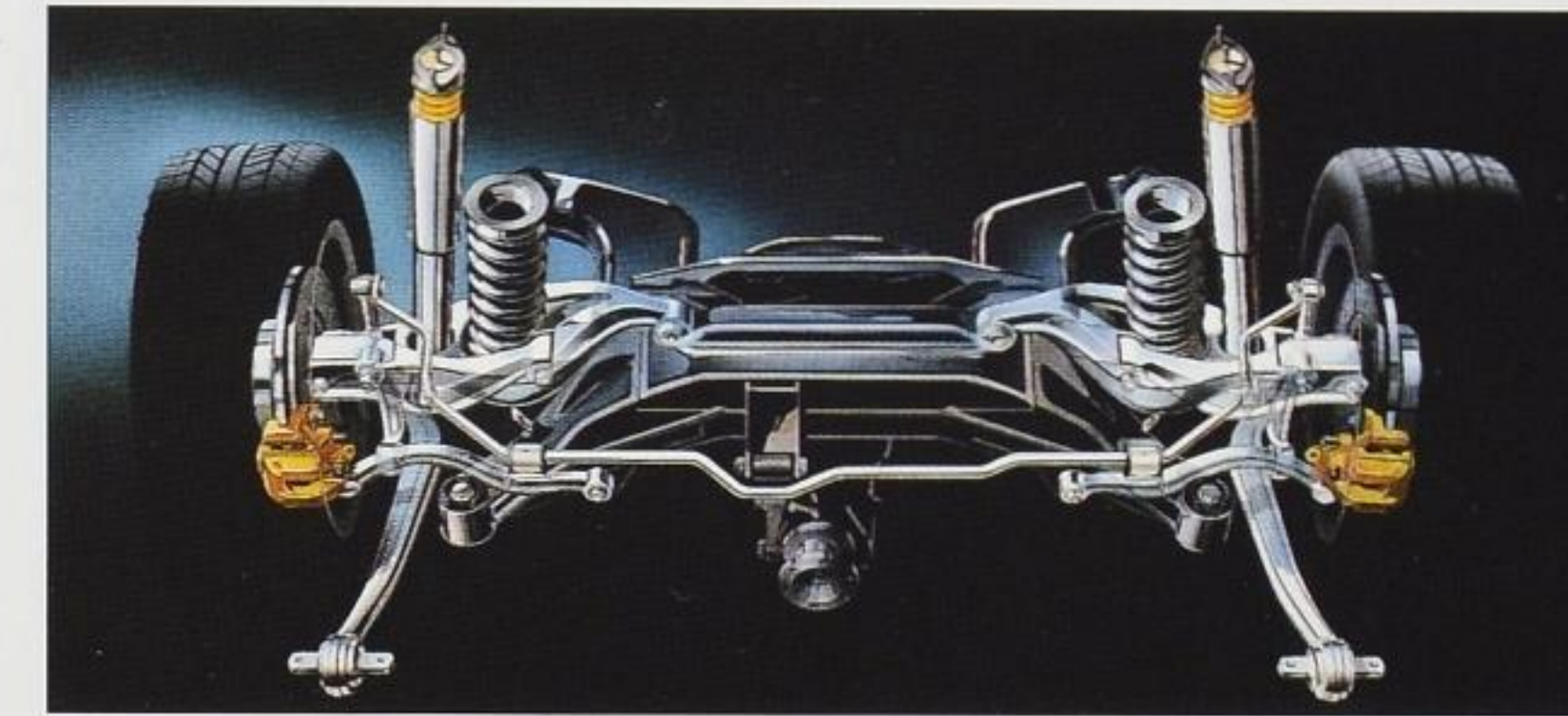

The sophisticated **multi-arm integral rear axle** guarantees supreme joy of motoring and excellent handling in every situation.

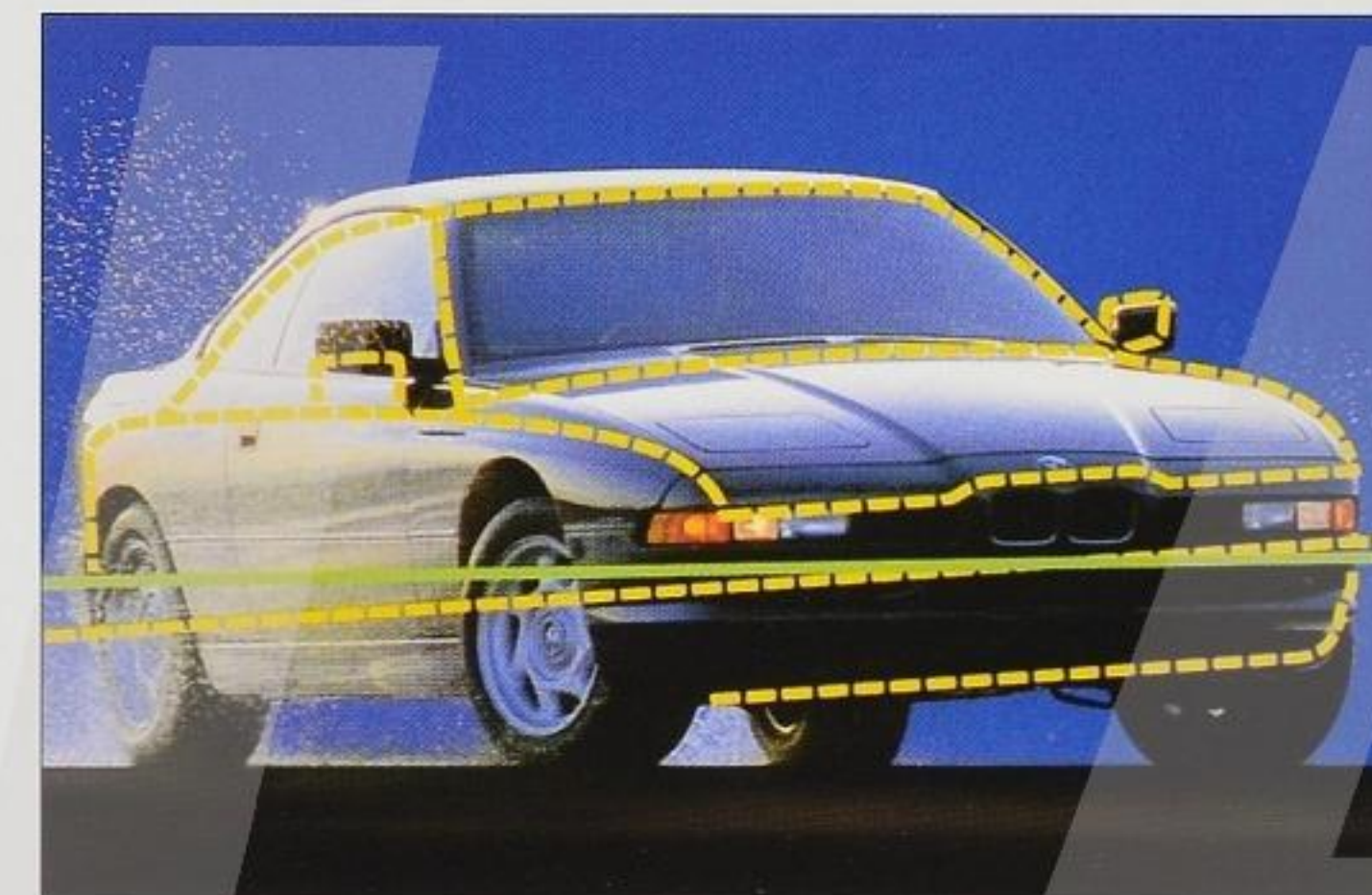

Electronic Damper Control (EDC) adjusts automatically to changing driving conditions and road surfaces. The result is extreme comfort and driving safety at all times.

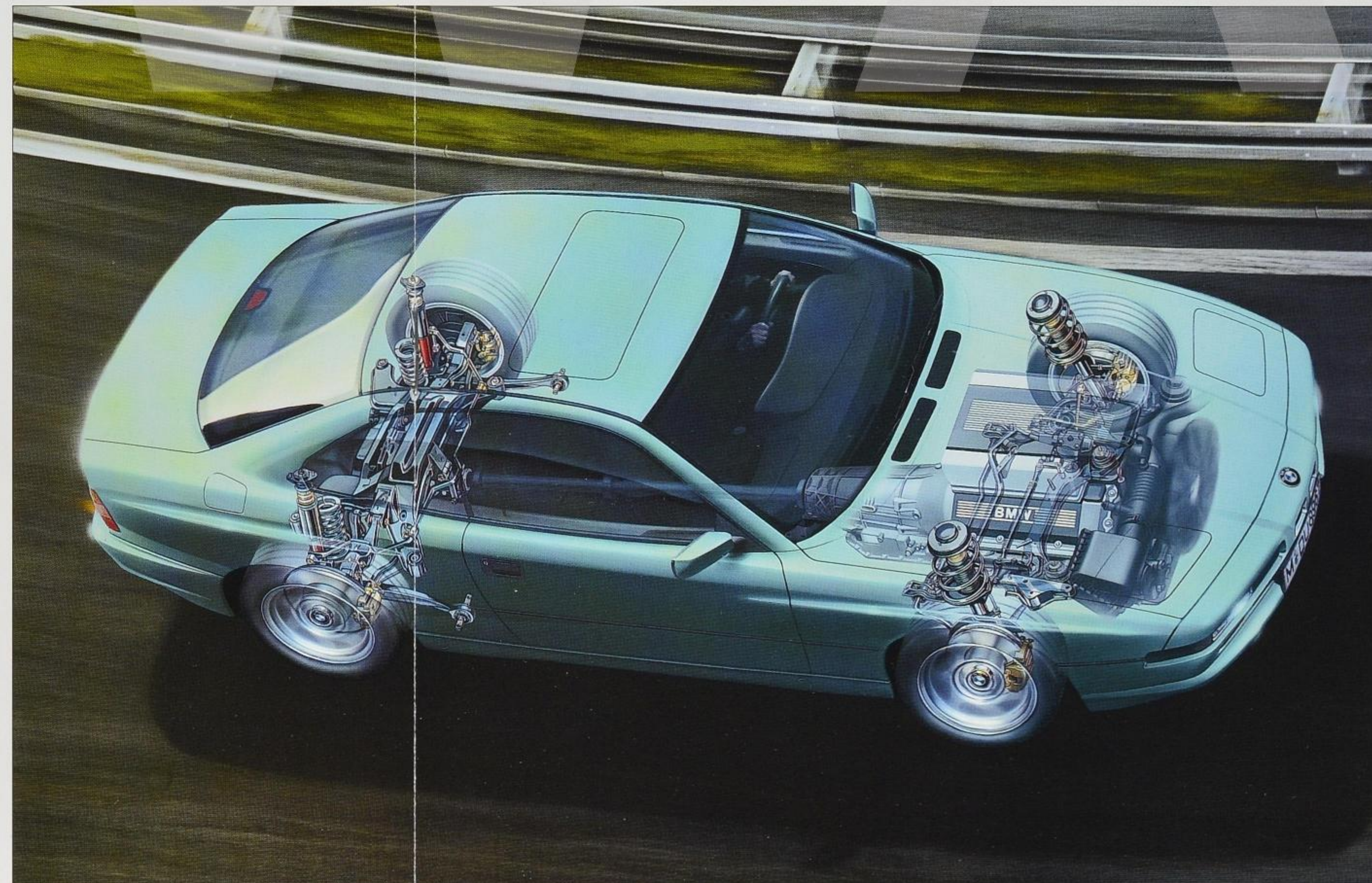

to the sides, and minimisation of any self-dazzling effect. The bottom line is that you can see pedestrians, cyclists, road signs and marks even more clearly than before.

The **constant-pressure screenwiper system** adjusts screenwiper pressure on the driver's side as a function of road speed, ensuring clear visibility for greater safety.

Electronic Damper Control (EDC) serves to provide extra safety and motoring comfort in one by automatically adjusting the dampers to different road, load, and driving conditions. Monitoring all movements of the car, an electronic control unit determines the optimum level of damper forces: When setting off, applying the brakes and in steering manoeuvres, damper forces are increased, when travelling at a constant speed they are reduced in the interest of greater motoring comfort. Apart from this automatic adjustment process, you can also choose a harder, firmer setting at the touch of a button.

Automatic Stability Control + Traction (ASC + T) prevents the wheels from spinning and guarantees optimum stability on the road. Up to speeds of 40 km/h or 25 mph, Traction Control (T) builds up additional brake forces. And since the left and right wheel are braked independently of one another, ASC + T acts like a limited-slip differential varying its locking effect from 0 to almost 100 per cent. Whenever the risk of the wheels spinning presents itself at higher speeds, engine management reduces drive forces to keep the car fully stable even in such a situation. A further point is that ASC + T may be deactivated where necessary, for example to provide wheel spin where desirable (eg when the car is snowbound or running on sand, etc).

BMW's F.I.R.S.T. (Fully Integrated Road Safety Technology) safety concept ensures optimum interaction of all safety features essential for comprehensive protection on the road: active and passive safety,

The experience is simply indescribable the minute you take your seat in the BMW 8 Series. You will be thrilled by the driver-oriented design of the cockpit and the exclusive range of comfort features. For what this means in practice is both a relaxed and a dynamic style of motoring, whatever you prefer.



The on-board computer gives you all the information you need quickly and efficiently, for exam-

ple the outside temperature or your estimated time of arrival.

Top-quality materials and perfect finish characterise the interior of the BMW 840Ci from top to bottom. Body-contoured seats with electrical adjustment as a standard feature offer freedom of space and excellent side support. And they significantly outperform even the strictest safety requirements applied by law, for example thanks to the seat-integrated belt system.

Technology Guide

protection of the vehicle itself and of other road users.

Driver and front passenger airbags make a significant contribution to your passive safety. Once a collision exceeds a defined minimum impact, sensors activate the airbag ignitors, inflating the airbags within milliseconds and softly cushioning the driver and front passenger. For safety reasons it is important that the passenger also wears his seat belt and keeps adequate distance from the glove compartment. Another point is to observe the directions for use when fitting child restraint systems on the passenger's seat.

On-board diagnosis is one of the functions of DME. Its task is to recognise deficiencies at an early point in time before they can do any harm. Signals indicating impending or sudden defects are memorised electronically and can then be displayed on the screen of the BMW Diagnostic Information System for exact evaluation by your BMW dealer.

The **memory function for electrically adjusting the driver's seat** allows you to retrieve any of three different seat positions and the appropriate position of the headrest and rear-view mirrors. All you do is press a button for the various settings memorised electronically.

The **seat-integrated belt system** on the extremely stable driver and front passenger seats developed especially for the 8 Series reduces forces acting on the occupants in a collision by more than 50 per cent compared with a conventional system. And at the rear the ergonomic belt system guarantees ideal belt geometry for occupants of virtually any size. The belts prevent your body from moving to the inside in a side-on collision and can easily be tightened with one hand.

Check/Control monitors all major functions and shows their condition or any deviation



Exclusivity to the last detail is ensured by a luxurious range of equipment with even the on-board computer and automatic air conditioning fitted as standard. And at the same time our concept of the

ultimate car is reflected by the user-friendly design of all controls and instruments.

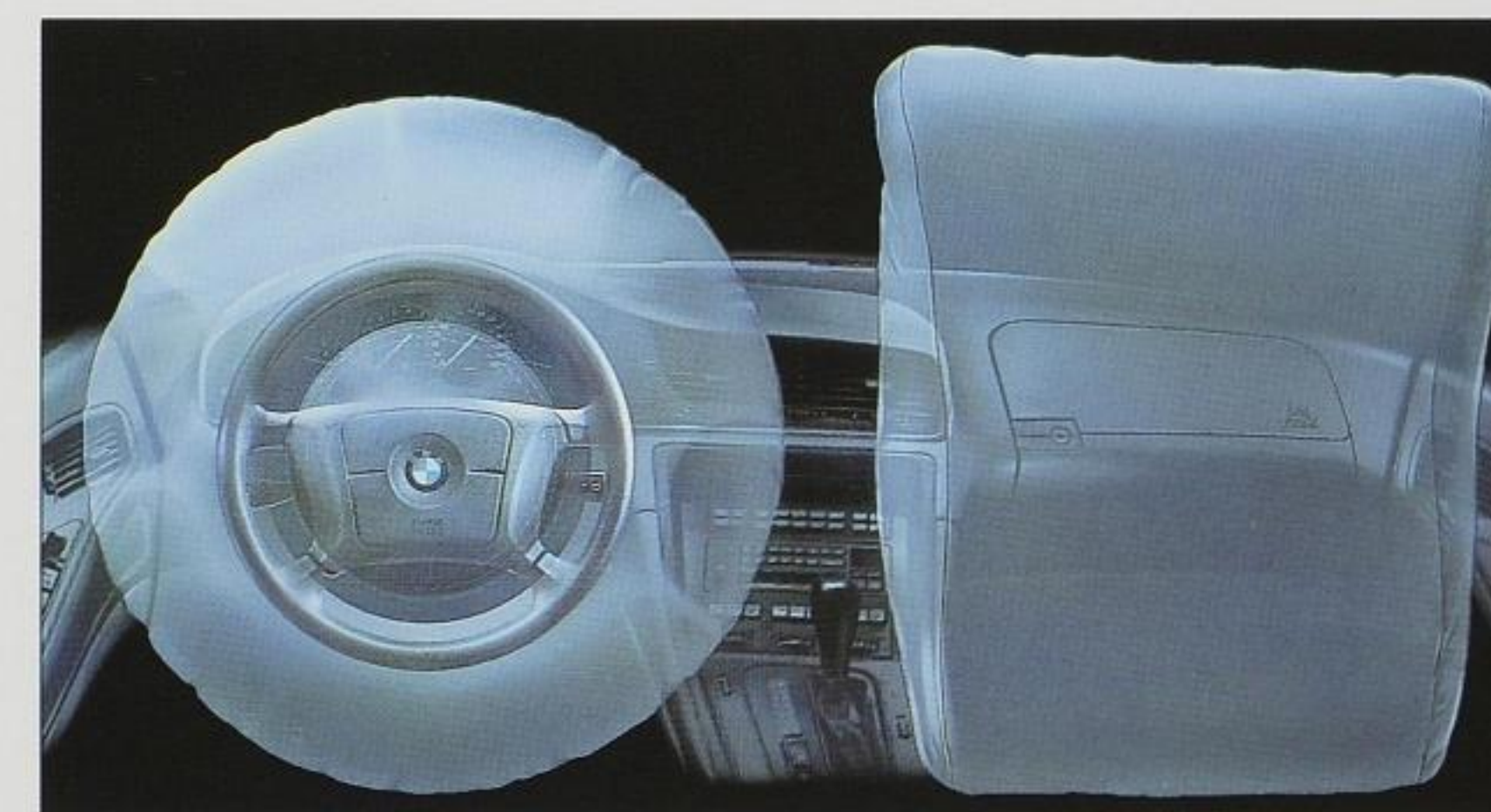

Fitted as standard, the driver and front passenger airbags cushion your head and

upper body safely and softly in a frontal collision. The front passenger's seat features a seat

occupation detector, i. e. the airbag can only be activated if occupied.

from proper operation. The lights are even checked when not switched on, information being presented once again by the display in the instrument cluster and supported by a sound signal, depending on the priority level of the message to be communicated.

The **on-board computer** offers the driver helpful information such as his average fuel consumption and average road speed, the distance to his destination, the distance he can still cover on the fuel in the tank, and the estimated time of arrival. All information may be retrieved at any time while on the road simply by pressing a button on the direction indicator lever, the data required then being shown by the display in the centre console and in the instrument cluster.

Also fitted as standard, **automatic air conditioning with microfilter** allows the driver and front passenger to choose their own air flow and volume on either side of the car. This automatic control and individual air distribution quickly gives you the temperature you prefer, which is then maintained consistently. And apart from automatic control, the air conditioning may of course also be controlled manually.

Automatic air recirculation (AAR) makes sure that harmful substances in the air do not get into the passenger compartment. Detecting substances such as carbon monoxide, nitric oxide and ethanol, the system automatically switches the heater and air conditioning to air recirculation for a certain period whenever the level of pollutants becomes excessive.

With **auxiliary ventilation** you can maintain temperatures at the level desired in the passenger compartment without even running the engine. The system may be programmed in advance by the on-board computer.

The **electronic immobiliser** safeguards your car with unique efficiency: The ignition key comprises an electronic



With the seat-integrated belt system all three belt pivot points move together with the seat when adjusted. As a result, you always have optimum restraint and protection regardless of your size and seating position.

Folding down one or both backrests at the rear provides additional storage space for your luggage. Further space with maximum privacy is then available in the compartment between the backrest and seat base.



code function based on your own, permanent personal code and a second code modified by the electronic immobiliser every time the engine is fired. Immediately when switching on the ignition, this "intelligent" system first reads your personal code and then checks the individual code varied each time. If both responses are accepted, the immobiliser transfers a coded signal actuating the Digital Motor Electronics (DME). Without this signal the engine cannot be started, not even by short-circuiting. The energy required for exchanging data in this way is conveyed by a transponder in the steering wheel lock, ie, through a wireless connection. Should the battery of the remote control key run flat, you can obviously still unlock the doors and start the engine. If, finally, you should lose your key, you can have it cancelled by your authorised BMW dealer and you will receive a replacement key immediately.

Fully driver-oriented in its design, the cockpit meets the highest demands in every respect: All primary information is right in the driver's line of vision and is shown clearly and unmistakably.



Waiting for your command: The electronic immobiliser will start the engine of your BMW only after verifying the code on the key of your car.

The 840Ci Sport – its aerodynamics package combined with the high performance suspension by M GmbH make an irresistible combination. Sports seats and larger alloy wheels complete the dynamic transformation.



BMW sports seats for the driver and front passenger assure optimum side support even at high speeds on winding roads. Even the thigh support and seat angle on the front passenger's side can be adjusted, all adjustment functions naturally being elec-

tric. As a further feature, the driver's seat is also available with memory function. BMW sports seats are not available in conjunction with the lumbar support.

BMW's forged light alloy wheels in M System II with directional styling accentuate the sporting character of the BMW 840Ci Sport:

8 J x 17 front wheels with 235/45 R 17 low-profile tyres, 9 J x 17 rear wheels with 265/40 R 17 tyres.



The two-part BMW light alloy composite wheels in the bolted cross-spoke style are tailored to suit the design of your BMW 840Ci Sport:

8 J x 17 front wheels with 235/45 R 17 low-profile tyres, 9 J x 17 rear wheels with 265/40 R 17 tyres.



BMW Service. The technical qualities and high standards we apply to our cars are also applied to the aftersales services we offer our customers.

In the area of service, our primary objective is first-class, personalised customer care. We want our customers to keep returning to buy BMW cars, and we recognise that only complete satisfaction, throughout ownership, will ensure this. Reliable and economical service begins with the development of BMW cars. Design concepts incorporate easy repair, while sophisticated technical systems, such as the BMW Service Interval Indicator and On-Board Di-

agnosis, ensure scheduling of services to match how the car has been driven and rapid and accurate diagnosis of faults. These systems are backed by a Dealer Network dedicated to delivering customer satisfaction. Their investment in technicians trained by BMW to BMW standards, and the most advanced equipment, designed by BMW for exclusive use on our cars, ensures you receive exemplary technical service. Their use of BMW Approved Parts also ensures cost effective servicing

and repair to the highest levels of accuracy and reliability to maintain your car to its original design qualities. Finally, for complete peace of mind, this is all backed by the 3 Year BMW Dealer Warranty with a 60,000 miles limit incorporating the BMW Emergency Service. The BMW Service Card represents your entitlement to this service, which in case of emergency, provides attendance and recovery throughout Europe, to get you and your car back home, or to your final destination.



BMW Finance (GB) Limited offers a range of financing options to suit the needs of BMW customers. Each package can be tailored to satisfy your particular requirements, whether it is for you as an individual or your business. BMW Finance will allow you to drive the BMW you choose at a budget you can afford.



No one gets you closer to the BMW you want than BMW Finance. Dedicated to the BMW motorist, BMW Finance offers a complete portfolio of finance facilities for the discerning BMW driver – for your own use or your business. The finance facility you choose can be matched to suit both your budget and your current and future motor-

ing requirements. BMW Finance also offers the option of budgeting your maintenance costs via BMW Contract Maintenance. Our range includes insurance, designed to the highest BMW standards, for carefree motoring and genuine peace of mind. BMW Finance facilities include:

- * Hire Purchase
- * Lease Purchase
- * Select

- * Leasing
- * Contract Hire
- * Guaranteed Payment Plan
- * Shortfall Insurance
- * BMW Insurance

If you require further information or details on any of the above finance facilities, contact either your local BMW dealer, or BMW Finance at the following address: BMW Finance (GB) Ltd, Ellesfield Avenue

Bracknell
Berkshire
RG12 8TA
Written quotations are available on request from your local dealer. Indemnities may be required. BMW Finance making your decisions easier. For details of your nearest BMW dealer please call 0800 325600.

Specifications.

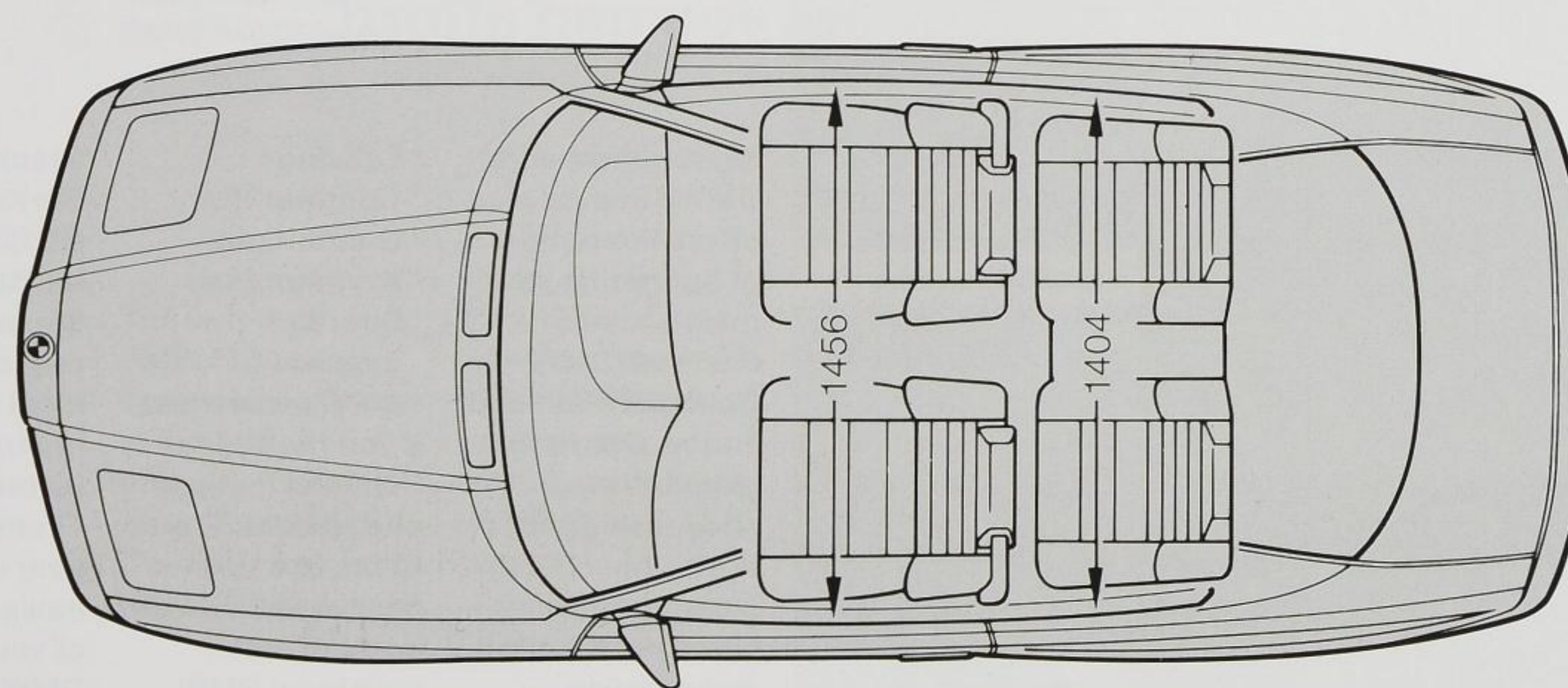
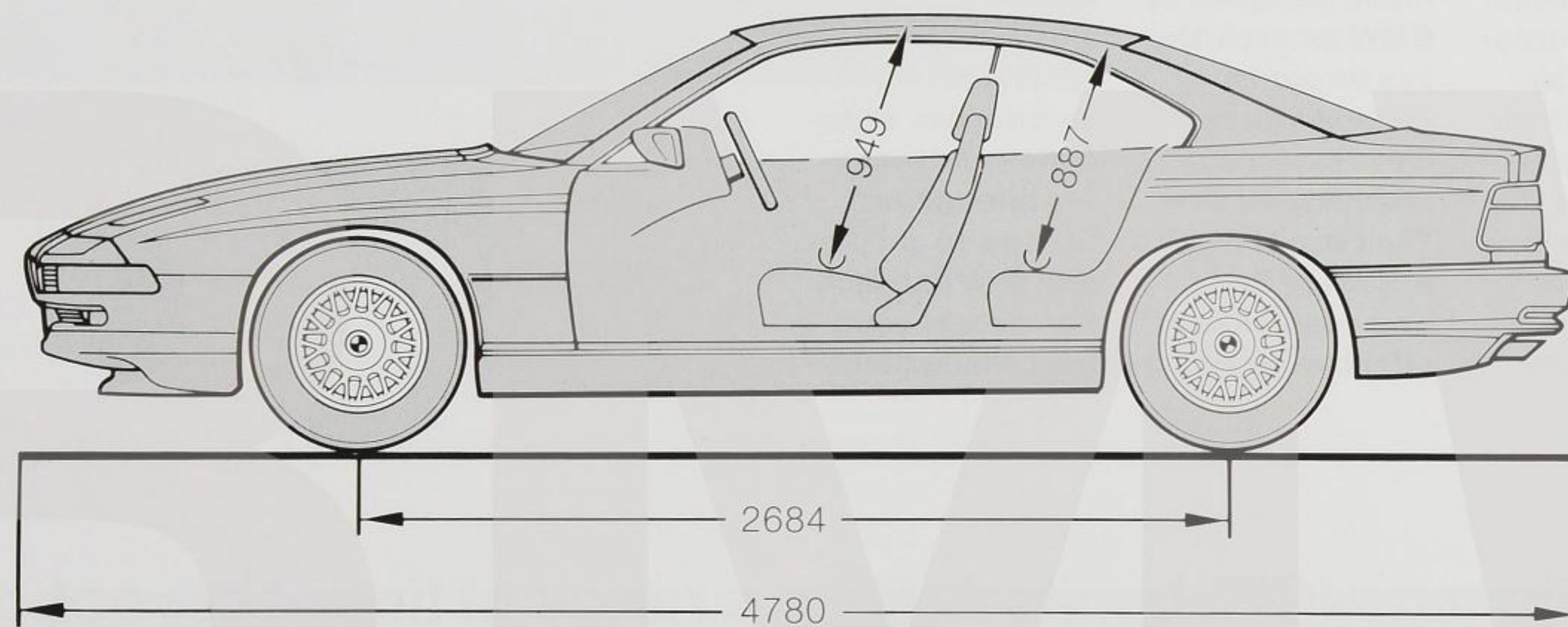
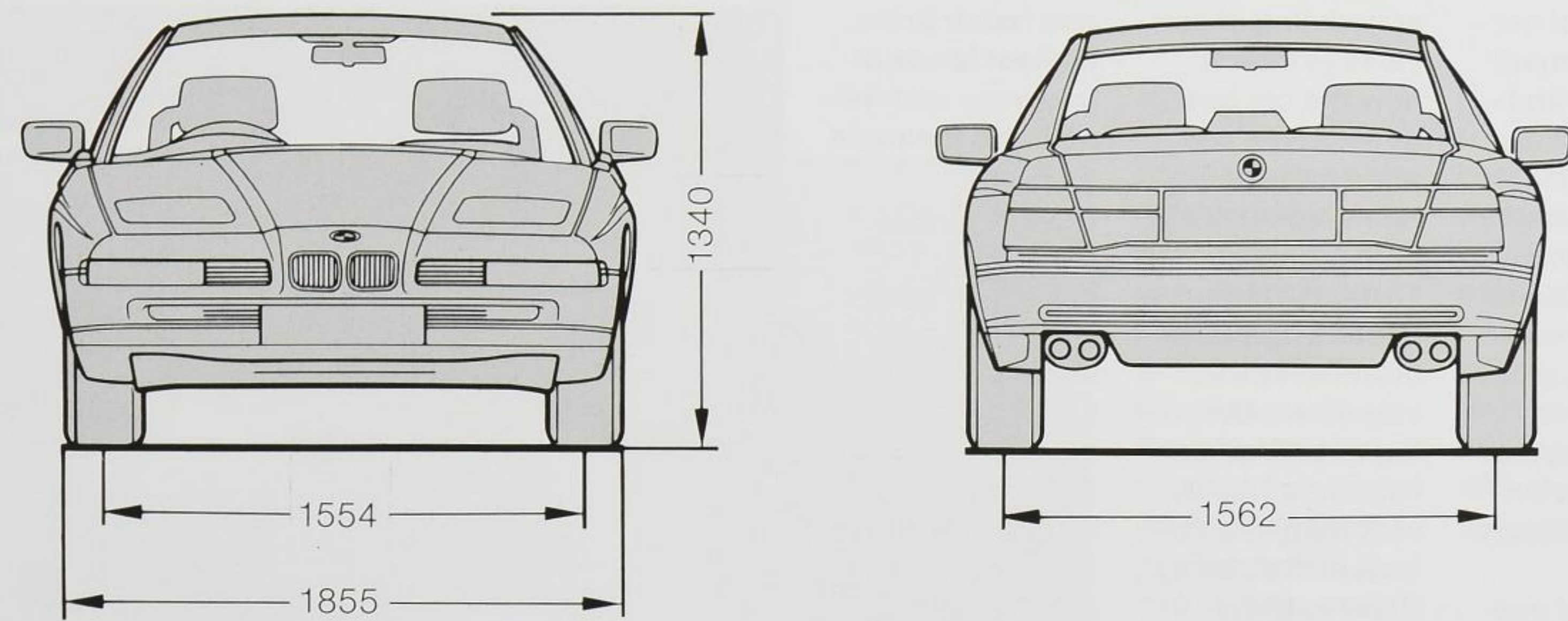

Figures apply to millimetres.

Weight		840Ci ¹⁾	840Ci Sport ¹⁾
Unladen ²⁾	kg	1895	1895
Max permissible	kg	2240	2240
Permitted load	kg	420	420
Permitted roof load	kg	75	75
Permitted trailer load unbraked/braked ³⁾	kg	750/1653	750/1653

Engine ⁴⁾		840Ci	840Ci Sport
Cylinders/valves per cylinder		8/4	8/4
Capacity	cc	4398	4398
Max output	kW/bhp/rpm	210/286/5700	210/286/5700
Max torque	Nm/ft-lb/rpm	420/310/3900	420/310/3900
Output per litre	kW/bhp/ltr	47.7/65.0	47.7/65.0
Torque per litre	Nm/ft-lb/ltr	95.5/70.5	95.5/70.5

Performance		840Ci	840Ci Sport
Drag coefficient	cd	0.29	0.29
Top speed ⁵⁾	km/h / mph	250/155	250/155
Acceleration 0-62 mph	sec	7.0	7.0
standing-start km	sec	27.1	27.1

Fuel Consumption ^{4) 6)}		840Ci	840Ci Sport
Urban	ltr/100 km / mpg	20.0/14.1	20.0/14.1
Extra-urban	ltr/100 km / mpg	9.5/29.7	9.5/29.7
Combined	ltr/100 km / mpg	13.4/21.1	13.4/21.1
CO ₂ emissions	g/km	319	319
Tank capacity, approx	ltr	90	90

Wheels		840Ci	840Ci Sport
Tyre dimension		235/50 R 16	Front: 235/45 R 17; Rear: 265/40 R 17
Wheel dimensions		7 1/2 J x 16	Front: 8 J x 17; Rear 9 J x 17
Material		Light alloy cross spoke	Light alloy in M System II styling

¹⁾ Specification data is for cars with automatic transmission and Steptronic.
²⁾ The figures shown include 68 kg driver weight and 7 kg luggage. Unladen weight applies to vehicles in standard trim. Optional equipment may increase this figure.
³⁾ With a max gradient of 12%. Trailer load may be increased. Contact your BMW dealer for detailed information.

⁴⁾ Engines with knock control are designed for RON 95 quality fuel. Use of RON 98 fuel reduces consumption under normal conditions and increases engine power accordingly. On RON 91 fuel engine power decreases and fuel consumption is higher.
⁵⁾ Electronically limited.
⁶⁾ Figures apply to directive 93/116/EC.

The models illustrated in this brochure show the specifications for the UK market. In part, they include optional equipment and accessories not fitted as standard. According to the specific requirements of other markets, alterations in models, standard and optional equipment, as described in the text and illustrations, may occur. For precise information, please contact your BMW importer or dealer. Subject to change in design and equipment.
 © BMW AG, Munich/Germany. Not to be reproduced wholly or in part without written permission of BMW AG, Munich.

Standard and optional equipment.

	840Ci	840Ci Sport
Safety		
Airbag for driver and front passenger, seat occupation detector	●	●
Anti-lock brake system (ABS)	●	●
Asbestos-free clutch and brake linings	●	●
Automatic adjustment of seat belt height and headrest level as a function of seat height adjustment	●	●
Automatic Stability Control + Traction (ASC+T)	●	●
Brakes:		
– Twin-circuit brake system with hydraulic brake servo	●	●
– Swing-calliper disc brakes at the front, inner-vented	●	●
– Swing-calliper disc brakes at the rear	●	●
Crash sensor	●	●
Crumple zones with predetermined deformation, integral side impact protectors	●	●
Ergonomic belt system at the rear	●	●
Seat-integrated belt system at the front	●	●
Servotronic power assisted steering	●	●
Power unit		
Camshafts with integral mass compensation	●	●
Crankcase and cylinder heads made of aluminium, cylinder head covers made of magnesium	●	●
Cylinder-specific knock control	●	●
Digital Motor Electronics (DME) with hot-film air mass metering	●	●
Eight-cylinder light-alloy power unit with four valves per cylinder	●	●
Fully sequential fuel injection	●	●
Intake manifold made of glass fibre-reinforced polyamide	●	●
On-board diagnosis	●	●
Solid-state distributor system	●	●
Transmission/suspension		
Anti-roll bars and gas-pressure shock absorbers front and rear	●	●
Double-joint spring strut front axle	●	●
Five-speed automatic transmission with Steptronic and Adaptive Gearbox System (AGS)	●	●
Multi-arm integral rear axle	●	●
Exterior features		
Bumpers front/rear in body colour, fully regenerating to their original position in impacts at up to 6 km/h (4 mph)	●	●
Constant-pressure screenwiper system, intermittent wipe related to road speed	●	●
Fuel tank capacity approx 90 litres	●	●
Green tinted heat-insulating glass all round, windows flush with body	●	●
High level third brake light	●	●
Low-beam headlights and foglamps in ellipsoid technology	●	●
Metallic paintwork	●	●
Pop-up headlights	●	●
Rear-view mirrors, lock on driver's door and screenwasher nozzles electrically heated	●	●
Sliding/vent roof – electrically operated	●	●
Wheels: light alloy	●	●
Interior features		
Automatic comfort close function of side windows when a road speed of approx 150 km/h (90 mph) is reached	●	●
Auxiliary ventilation	●	●
Carpet in high-quality soft velour	●	●
Central locking of doors and luggage compartment by remote control	●	●
CFC-free automatic air conditioning with microfilter and Automatic Air Recirculation (AAR)	●	●
Chrome-plated door cut-out embellishment	●	●
Diversity antenna integrated in rear window	●	●
Door and side panel inserts in nappa leather	●	●
Door lights in door cut-outs at the front	●	●
Electric window lifts front and rear, with fingertip operation and trap release at the front	●	●
First-aid kit in storage box opening up between rear seats	●	●
Front seats in standard design, electrically adjustable with driver memory function	●	N/A
Gearshift lever knob and gaiter/selector lever knob and gaiter finished in leather	●	●
Handbrake lever knob and gaiter in leather	●	●
Individual body contour of rear seats	●	●
Instrument cluster, speedometer and rev counter with analogue face, LCD mileage counter, Check/Control	●	●
Interior rear-view mirror with automatic anti-dazzle effect (electrochromatic)	●	●

	840Ci	840Ci Sport
Leather upholstery in natural-grain nappa leather on the seats, including inserts in the door and side linings	●	●
Luggage compartment capacity 320 ltr (11.2 cu ft) (to VDA standard)	●	●
Map reading lights at the front	●	●
Multi-Information Display (MID)	●	●
Multiplex technology for instruments, body electrics, and door functions	●	●
On-board computer	●	●
Radio/cassette player BMW Business RDS with twelve loudspeakers and preparation for CD player	●	●
Rear seat backrests folding down separately	●	●
Seat adjustment electric, with memory function on driver's seat	●	●
Side windows frameless	●	●
Side windows moving up and down automatically by approx 6 mm when opening and closing doors	●	●
Side windows with comfort opening function by remote control	●	●
Ski bag mounted between backrest of rear seats	●	●
Steering column manually adjustable for reach	●	●
Vanity mirrors, illuminated	●	●
Velour carpet mats	●	●

Security		
Anti-theft warning system with tilt angle alarm, including remote control	●	●
Central locking with dead lock	●	●
Electronic immobiliser, passive arming	●	●
Freewheeling steering lock cylinder	●	●
Visible chassis number on dashboard	●	●

Optional equipment		
Aerodynamics package including front airdam and rear diffuser, M exterior mirrors	N/A	●
Anthracite headlining	N/A	●
Automatic speed hold	△	△
Electronic Damper Control (EDC)	△	△ ¹⁾
Graduated tinted front and rear screens	△	△
Headlamp cleaning system with intensive cleaner	△	△
Lumbar support for driver's and front passenger's seat	△	N/A
M-leather steering wheel with airbag	△	●
M-sports suspension	△	●
No model inscription	△	△
Piping on leather upholstery (front seats only)	△	△
Sports seats with adjustable thigh support	△	●
Steering column adjustment, electrical	△	△
Sunblind on the rear window, electrically operated	△	△
Upholstery: natural buffalo leather ²⁾	△	△
Wheels: light alloy in M-System II styling	N/A	●
Wheels: light alloy in turbine styling – 235/50 R 16 tyres	△	N/A
Wheels: light alloy two-piece in bolted cross-spoke styling – 235/45 R 17 front, 265/40 R 17 rear	△	N/C

● standard △ optional N/A not available N/C no cost option







¹⁾ not available with M-sports suspension

²⁾ includes sunblind on rear window, electrically operated

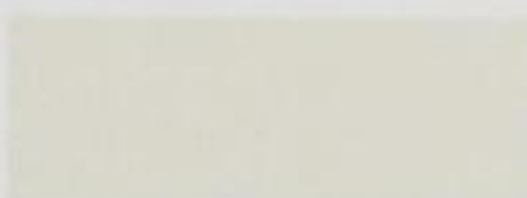
All of the options and special equipment listed here are available fully installed ex works. To meet any further requests you might have, we offer a wide range of BMW accessories developed by BMW and in BMW quality. For further information, please contact your BMW dealer, who can offer you helpful advice and a special accessories brochure.





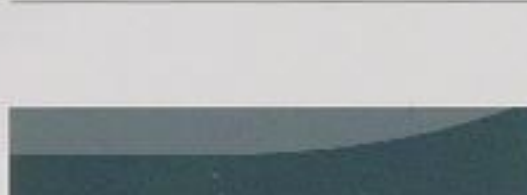
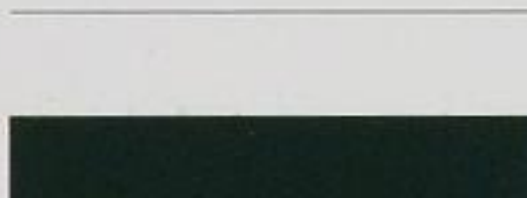
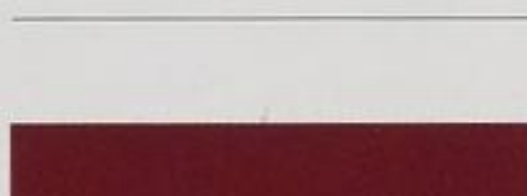
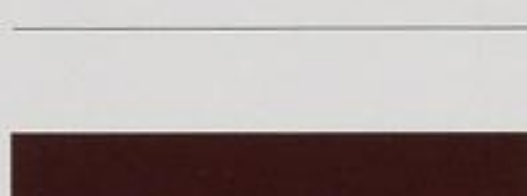
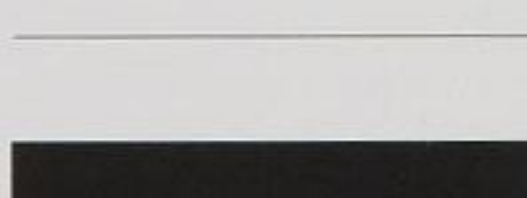



Exterior and interior colours.

- Recommended.
- Available.

Exterior Colours		Interior Colours					
		Black	Silver-Grey	Light Silver-Grey	Parchment	Light Parchment	Anthracite (buffalo)
840Ci/840Ci Sport		Leather					
Non-Metallic	 300 Alpine White	●	○	○	○	○	●
	 314 Bright Red	●	○	○	○	○	●
	 668 Jet Black	●	●	●	○	○	●
Metallic	 309 Arctic Silver	●	●	●			●
	 310 Fjord Grey	●			○	○	●
	 317 Orient Blue	●	●	●			●
	 247 Barbados Green	●	○	○	○	○	●
	 324 Oxford Green	●	○	○	○	○	●
	 252 Calypso Red	●	●	●	○	○	●
	 343 Canyon Red	●			●	●	●
	 303 Cosmos Black	●	●	●	○	○	●

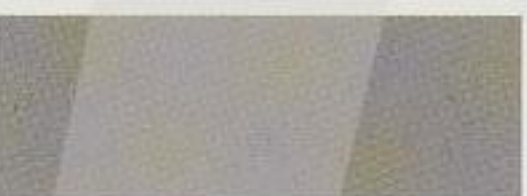
Other colours are available for the 840Ci Sport at extra cost. For more detailed information please contact your BMW dealer.

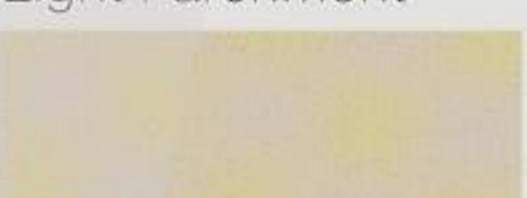
Materials.

	Standard	Option
Model	840Ci/840Ci Sport	840Ci/840Ci Sport
Material	Leather 	Natural Buffalo Leather 
Interior Colours		
Anthracite 		M6AT
Light Silver-Grey 	M5SH	
Silver-Grey 	M5SL	
Parchment 	M5PE	
Light Parchment 	M5PH	
Black 	M5SW	

These are the various upholstery and paintwork options available for the BMW 8 Series. The interior colours are harmoniously matched for leather upholstery. Since colours printed on paper cannot properly render the true colour of paintwork and upholstery, we advise you to check the original colours at your BMW dealership. Please see the table for possible combinations of paintwork and upholstery on all models. Subject to change.

BMW AG

**We invite you to enter
the world of BMW.**

Words and pictures are often not
enough to describe an outstanding
car. Which is why we would like
to offer you the opportunity to view
and test drive the BMW 8 Series
Coupé by contacting your nearest
BMW dealer.

Further information can be found on
the Internet: <http://www.bmw.co.uk>



The Ultimate Driving Machine